



TRTR-2005 / IGORR-10 Joint meeting

September, 12-16, 2005

Gaithersburg, Maryland, USA

Jules Horowitz Reactor experimental capabilities

Authors :

Claude Pascal¹, Yves Demoisy², S.Gaillot³, X.Bravo³, F.Javier³

¹ AREVA Technicatome, JHR Project, 1100 rue Jean René Guilibert Gauthier, F – 13100 Aix en Provence

² AREVA Framatome-ANP, JHR Project, 1100 rue Jean René Guilibert Gauthier, F – 13100 Aix en Provence

³ CEA-Nuclear Energy Division, JHR Project Reactor, Building 780, CEA Cadarache, BP1, F-13108 Saint Paul lez Durance Cedex

Abstract :

As an international user-facility, the Jules Horowitz Reactor (JHR) will provide a modern experimental capability for studying materials and fuels behaviour under irradiation for applications such as,

- support to nuclear power plants of generations II and III,
- developments for future generations of reactors,
- radio-isotopes production for medical applications .

The design of the facility is performed according to the most modern requirements of safety regulations ensuring the quality and the safety of the experiments.

JHR integrates in the nuclear unit all the experimental equipments allowing carrying out experimental irradiations, intermediate controls and associated examinations.

The JHR includes:

- a high performances and flexible reactor able to perform 16 dpa/year damages on materials,
- high thermal flux allowing to reach in the reflector 600 W/cm on a 1% enriched LWR fuel pins,
- hot cells with a specific alpha cell allowing to perform all the operations on degraded fuels,
- a chemistry and dosimetry laboratories,
- cold and hot workshops.

This paper presents the experimental capabilities of the various systems of the JHR, the main lines of the reference frame relating to the experiments preparation and realization and the design requirements allowing to be in agreement with the preliminary safety analyses reports.

Keywords: JHR, experimental capabilities , experiments processes , hot cells, FP lab , non destructive examinations

1. Introduction

The experimental field covered by the JHR addresses irradiation experiments on fuel samples, and materials for programs concerning :

- Support power plant operation of existing and coming reactors (Gen 2 & 3) for material ageing and plant life management,
- Support design evolutions for Gen 3 power reactors (that will last all the century) such as performance improvement and technological breakthrough in the fuel cycle to meet new stakes regarding for example actinides management,
- Support fuel performance and safety margins improvements with a strong continuous positive impact on Gen 2 & 3 reactor operating costs and on fuel cycle costs (burn-up and duty-cycle increase for UOX and MOX fuel) ,
- Support fuel pin qualification in incidental or accidental situations,
- Support fuel optimisation for High Temperature Reactors,
- Support the material & fuel assessment and development for Gen. IV innovative systems (VHTR, GFR, SCWR, LFR ...) and qualification for SFR.

2. Description of the experimental capabilities

The JHR experimental capabilities allow performing :

- Commissioning and acceptance tests of devices and, if necessary, experimental samples planned for the irradiation test (if there is no risks of contamination or irradiation),
- Capability to handle different types of samples, with its important capacities of transport cells,
- Final assembling of devices in a workshop or in a hot area of the facility, using new components or recycling parts.
- Non Destructive Examinations at different phases of the experience (measurement before irradiation on NDE systems) or on devices (neutronography, X radiography, gamma spectrometry):
 - On systems located in the reactor pool,
 - On systems located in hot cells equipped with specific NDE measurements for irradiated samples,
- Preparatory tests on devices (performance controls, regulation, start up),
- The irradiation sequence associated with :
 - A specific area dedicated for the experiments driving, accessible for scientific staff,
 - Specific instrumentation for the device allowing to control and drive the experience,
 - On-line and delayed Fission Products measurements released from the sample, in the cooling flow and using specific equipments in a dedicated laboratory located in the facility and directly connected with the experiments.
 - Chemical measurements on samples obtained from the experiments, performed in chemical laboratory (HPLC, ionic chromatography, mass spectrometry, electrochemical analyses,...) ,
- Sample recuperation during or at the end of the experience, using three dedicated hot cells allowing to perform the necessary operations, manipulation, visual examination, characterisations on NDE systems, or device reloading in order to continue the irradiation sequences for :

- Material samples (fuel clad, internal structures,...),
- Fuel samples (for fuel qualification tests),
- Specific samples (failed clad , damaged or molten fuel). For this type of test, an innovative cell called « alpha cell » is foreseen.
- Recovery and dosimeters exploitation to give the neutron flux distribution on each device, in a dosimeter laboratory integrated in the facility.
- Conditioning operations and outlet lines use to send samples to externals hot cells or laboratories on the CEA sites or in others companies.

The diagram below summarises the experimental process of an irradiation sequence in the JHR.

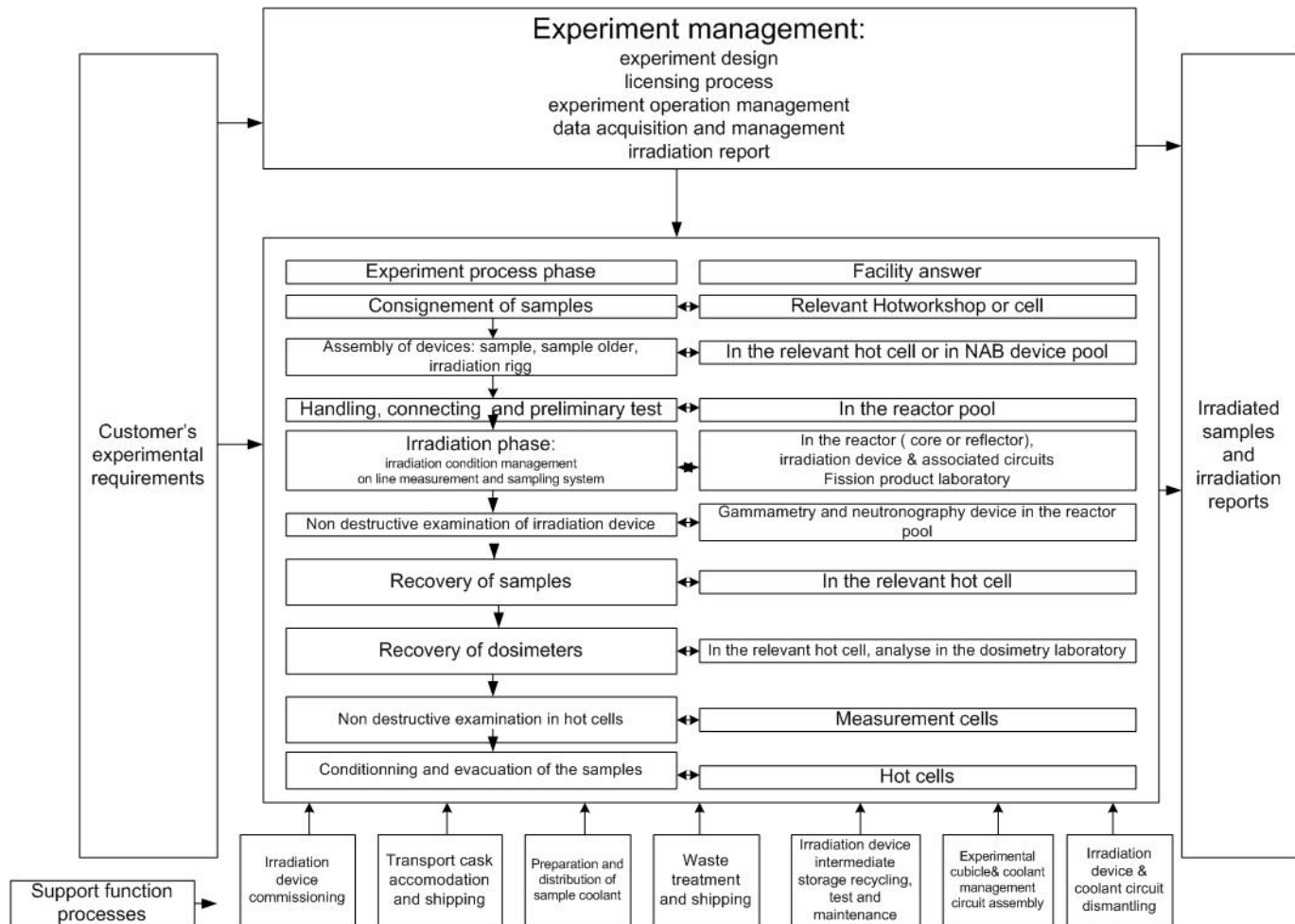

3. Acceptance and preliminary tests on devices (workshops, cold and hot areas) :

The JHR includes several pieces of equipments for the commissioning of the new devices which will be used to carry out experiments:

- a cold workshop independent but near the nuclear unit, established in a non nuclear building for the commissioning and the assembly final of new devices, and if necessary the performance of tests with samples of inactive materials,

- hot workshop, integrated into the NAB (Nuclear Auxiliaries Building) , allowing to carry out assemblies, commissioning and tests of devices including fuel samples or sensitive materials (the operations on active matters must be necessarily carried out in controlled area concerning radiological zoning, the operations on sensitive materials must be carried out in zone with reinforced protection dealing with physical protection).

The hot workshop is classified as a non-contaminant zone regarding waste zoning in order to allow, in case of non conformity noted during the commissioning tests, a possible return of the device back to the supplier.

The purpose of these commissioning tests are to check that devices are manufactured consistently with RCC-MX code (design and manufacturing rules).

They consist of :

- controls carried out for the customer: statistical or systematic dimensional checks, materials taking away, etc,
- examination of manufacturing reports,
- functional tests.

Experimental device includes all the components necessary to carry out an experiment:

- the sample carrier,
- the connection lines (which make it possible to transfer information, coolants or carrier gas between the devices and the "ground base"),
- jigs of non destructive testing on samples which could be developed specifically for the experiment,
- circuits and systems to be designed or which constitute the experimental cubicles,
- test benches specific to the device which could become compulsory for commissioning or periodic testing.

The workshops are dimensioned for handling with the vertical or horizontal envelopes of devices considered for the design of the JHR and whose key features are as follows:

- overall length up to 6.5 m,
- overall mass 500 kg.

They meet the codes for design and manufacturing issued from the RCC-MX (cleanliness, dust contamination, etc.) as they are intended for the handling and the assembly of components having to be placed in the reactor.

They are provided with :

- equipment hatch able to reach the requirements of cleanliness, radiological zoning and waste,
- their own handling equipment (conveying device, monorail, conveyor beams integrated into certain hatches),
- wells or available heights allowing the introduction of the sample holders into the vessels to form the various devices (that is to say the available height of about 13 m)
- test benches used to carry out commissioning (for example hydraulic test benches to check the flow characteristics inside devices),
- coolant filling systems (conditioned water, NaK, Na,...),
- all utilities necessary for their operation.

4. Consignment of the samples (castles, storage in reactor pool,...):

The JHR has an important capability of consignment of samples either in terms of interfaces compatible with a large variety of material or fuel samples packing (irradiated or not) for transport or in term of storage capability.

It can handle via the truck access hatch varied transfer casks up to 45 tons.

These casks can be connected vertically (to a hot cell for handling and directing) or horizontally (from the rear zone of the cells to several stations having interfaces adapted to various types of castles, from simple connecting technology with sealing ensured by inflatable seals to tight and reversible systems of transfer).

In this case, the overall dimensions of the castles capable of being connected to the hot cells are : diameter: 1m, length: 3.7 m, mass: 25 tons.

Should the many castle interfaces associated with the cells are not adapted to particular casks, the storage pool of irradiated components can, with adaptations (safety devices in the bottom of the pool designed for the fall of load), accept casks for underwater loadings.

The JHR also has a great capacity of storage, for instance in the storage pool of devices, in specific packing (storage poles), irradiated samples materials and fuels.

Storage pool for devices and samples

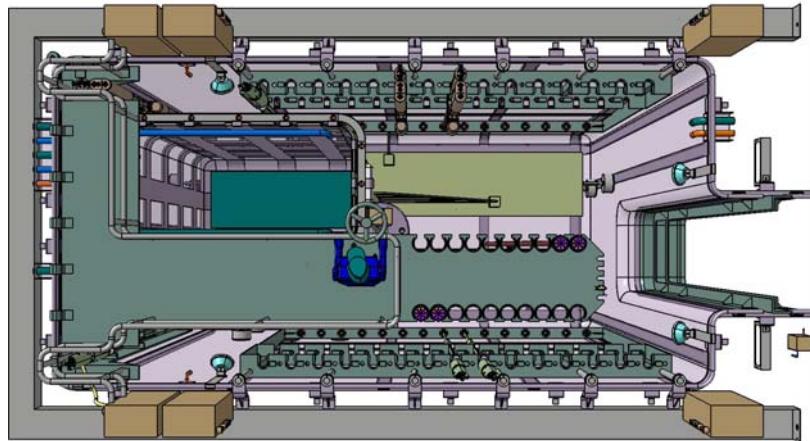

5. Assembly of the devices (workshops, reactor pool, laboratories):

According to the history and the nature of the devices and samples to be handled, the cold workshop, the hot workshop, the storage and work pools and the hot cells allow carrying out the assembly and the preparation of the devices:

- the mechanical assembly of the devices,
- the final equipment of the devices (instrumentation, particular components), including possible re-use of components recovered on dismantled devices,
- the loading of the device with its samples and dosimeters,

- the filling with the coolant chosen for the experiment (conditioned water LWR, BWR NaK, Na, etc...).

For new devices and not irradiated materials samples, assembly will be performed in the cold workshop, whose characteristics are:

- surface of about 200 m²,
- dimensions allowing the handling of devices of up to 6.5 m in length,
- assembly wells allowing the introduction of sample holders into device containers,
- possibility to house, hydraulic test benches capable of simulating the conditions of flow around the devices in core or reflectors,
- cleanliness equivalent to an operating area RCCM-X "level 1" (hatch to limit the dust contamination, changing room for personnel, purification and air conditioning comparable to clean rooms,
- capacity of handling test benches on devices,
- various means to allow the handling of devices etc.).

Settled in a non nuclear building located close to the reactor, this workshop is accessible without constraint for outside companies.

For new devices and samples to be handled in controlled zone, the hot workshop called "not contaminated zone" allows a direct handling of these components.

This workshop has a specific access allowing the introduction of devices in the vertical position (necessary for devices filled with coolants requiring to maintain a gas gap).

The hot workshop access is limited.

- For devices made of components recovered from devices having been irradiated, the hot workshop called "contaminated zone" allows, thanks to a glove box having a very important height, the handling of low activities (contamination and/or irradiation).

The possibility of re-using components recycled from certain devices (specific connectors, instrumentation, actuators such as strain gauges, etc.) is a valuable possibility reducing irradiation cost and wastes.

Any tools or assembly bench introduced into this hot workshop, taking into account waste zoning associated with this room, is to be considered as a nuclear waste (very low activity type at minimum).

- For irradiating components, the assembly and the preparation would be carried out with manipulators in one of the hot cells of the facility (materials, fuels or alpha cells) or on the two workstations located over the storage pool for devices (according to the nature of the operations of assembly carried out, components from devices irradiated and/or contaminated, the history of irradiation, etc.).

Hot cells offer the possibility of handling sources equivalent to an activity de 100 kCi of Co⁶⁰ for the γ radiations.

Hot cells include workstation with precision manipulators (capacity 20 daN), heavy manipulators (capacity 100 daN), handling units for lifting (capacity 25 kN), wells for vertical travel of the devices and their storage, utilities and possibilities of introduction of coolants, or television equipments.

The conditioning/material cell includes means for obtaining an inert atmosphere by nitrogen sweeping allowing the assembly and the filling of devices with liquid metals used as coolants (NaK, Na,...).

6. Preparation and distribution of various coolants representative of the studied reactor technologies:

JHR includes equipment for storage, preparation and distribution of coolants for several types of power reactor (water, molten metals, gas) available for experiment services:

- a laboratory for producing water at given chemical conditions (LWR,BWR,...), with controlled boric acid, lithine, hydrogen, etc.
- storage capacities for specific coolants (Na, NaK, PbBi,...),
- an inactive chemistry laboratory for chemical analyses before introduction of coolants into the nuclear unit.

These equipments are installed in buildings close to JHR's nuclear unit.

Equipments for distribution and transfer making it possible to guarantee the quality and stability of the chemical characteristics of these coolants are also available.

7. Irradiation capabilities:

a) reactor design features

The JHR provides a large volume, high-flux test locations for several purposes:

- Experimental devices irradiation,
- Radioisotope production for medical or industrial uses,

The reactor concept selected to achieve customers requirements is a tank reactor in a pool research reactor operating at up to 100 MW. This design is fully compatible with radial power ramps on the fuel samples in the reflector.

View of the reactor pool

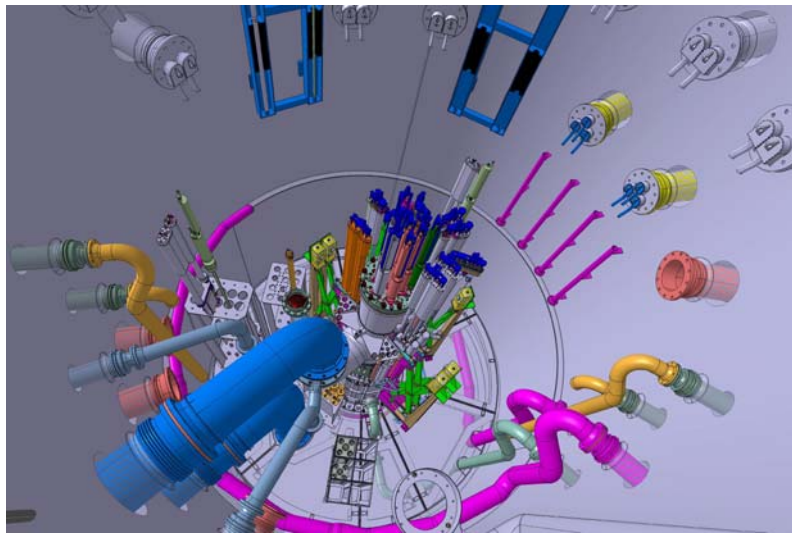

The core is cooled and moderated by circulation of light water which flows upstream in the sealed primary cooling circuit. Water enters the vessel at the bottom, flows up in a cylindrical tank which contains the fuel elements. At shutdown, the core cooling is ensured by forced convection and the residual power is transferred into the reactor pool. A unique fuel element is used for all core configurations. The irradiation devices located in the core may be cooled by the reactor primary circuit.

The core is surrounded by a modular reflector of beryllium which is constituted by 12 sectors housing 5 different types of block in order to ensure a maximal offer in geometric capabilities of the irradiations locations. The reflector is cooled by the pool water which is sucked through the reflector elements by the reactor pool cooling circuit. This circuit ensures cooling of the irradiation up to a total power of 2 MW. At shutdown, the reflector is cooled by natural convection and the residual power is transferred into the reactor pool. Long term cooling systems are provided in order to extract the residual power from the reactor pool. The irradiation locations are located in the core and in the reflector.

View of the core and the part of the primary circuit

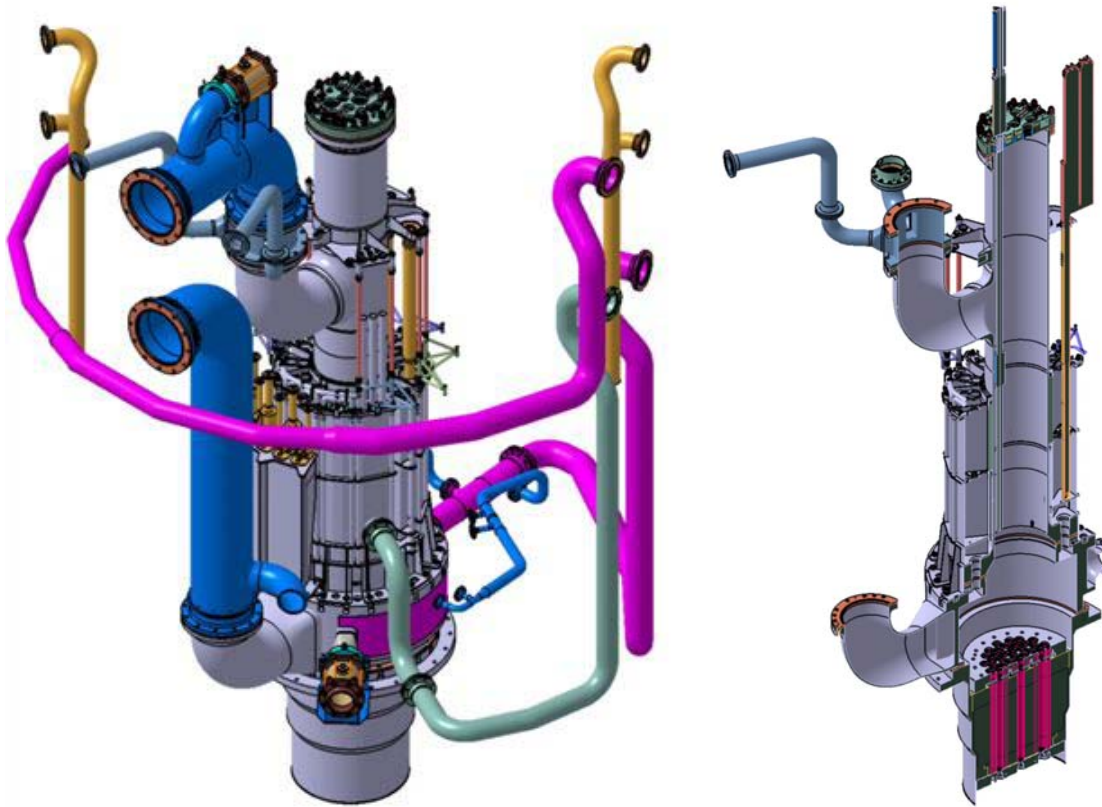

The normal operate of the JHR is at maximum 270 days each year in 9 cycles with 6 days for routine shutdown, and 23 days for summer shutdown for maintenance and inspection operations.

In the core, experimental devices are maintained by the reactor vessel lid, and in the reflector they are maintained by dedicated structures (reflector supporting structure or displacement devices).

The design of the reactor allows the removal of experimental devices from the reactor:

- independently from the reactor power when the device is located on a displacement device, after being positioned in the rear position. This is also the case for most devices located in the reflector,
- between one to 12 hours after reactor shutdown when the device is located in the core.

Due to the control rod location in the center of the fuel element, the core design allows for an optimal stability of fast fluxes in the core. Hence, the stability of core fluxes is better than 5% in terms of fast flux and better than 7% in terms of thermal flux evolution. This is due to the consumption of the U_{235} during the cycle. The flux in the reflector is intrinsically very stable. 2 reactor configurations are investigated:

- the **reference configuration** with the aim to meet :
 - very high flux requirements (up to 16 dpa/year in the core and a linear power 600 W/cm on typical LWR fuel rods whatever the burn up achieved in the reflector),
- an important irradiation location capability :
 - 10 irradiation locations inside the core
 - * 7 small locations which are located in the center of a fuel element,
 - * 3 large (threefold) locations instead of a fuel element,

- 6 irradiation locations in the reflector for experimental devices on displacement devices,
 - 6 irradiation locations in the reflector for experimental devices
 - 9 Artificial Radio-isotopes production devices in the reflector,
- the **large configuration** with the aims to meet:
- high fluxes (up to 13 dpa/year in the core and a linear power 730 W/cm on typical LWR fuel pins with the burn up equivalent at 2,25% U_{235} in the reflector,
 - a larger number of irradiation locations: an important irradiation location capability :
 - 12 irradiation locations inside the core,
 - * 6 small locations located in the center of a fuel element
 - * 4 large (threefold) locations instead of a fuel element,
 - * 2 very large (instead of three slots) locations,
 - 8 irradiation locations in the reflector for experimental devices on displacement devices,
 - 8 irradiation locations in the reflector for experimental devices,
 - 9 Artificial Radio-isotopes production devices in the reflector,
 - the specification of refuelling the core without removing 2 experimental devices in the core.

The versatility of the design is optimum for the reflector due its modular design. Also, the reactor design allows a change of configuration achieved within 2 months.

view of the core - reference configuration

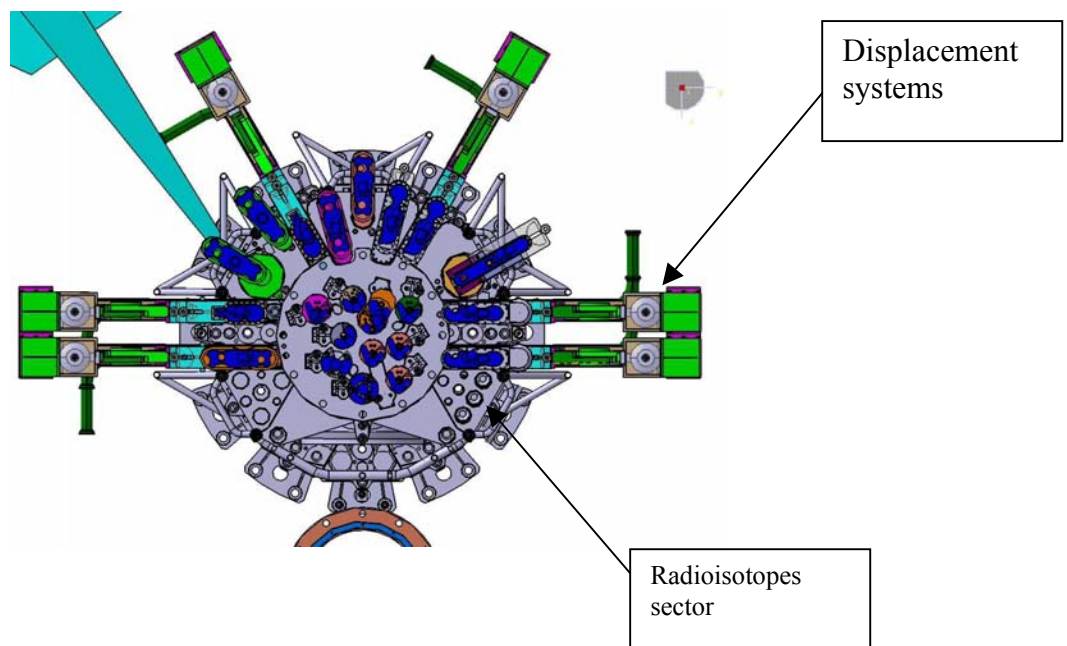

b) Experimental area in the reactor building

The experimental area in the reactor building is divided into an experimental cubicle area which houses coolant chemistry management circuits and the relevant safety circuits. This system is located at the bottom of the building and command control room cabinet area is located at the upper part of the reactor building.

The design is based on a capability of 25 experimental devices: the interface design criteria includes 15 capsules, 4 compact loops, 6 experimental loops. 12 of them have their coolant management circuits located in the experimental cubicle area. In addition, 2 cubicles are on standby for assembly, commissioning or decommissioning of experimental device circuits. The experiment personnel access route is independent from the reactor hall access. These areas integrate dedicated ventilation circuits in order to optimize the connection between the extraction from experimental cubicle and the relevant network in terms of contamination risk. The relevant access route for circuits, power distribution and control network regarding safety requirements (segregation, internal hazard,...) are integrated in the design. The final assembly of the different systems will be defined in adequacy with experimental programs at the start of the facility life.

The experimental area characteristics are:

- Control rooms total surface area over 3 floors: 490 m²
- Experimental cubicle total surface area over 3 floors: 780 m²
- loading specifications for the floor is 6 tons/m² and up to 10 tons/sqm (locally).
- Penetrations between the reactor pool and the experimental cubicle area:
 - 9 from the reactor pool to the experimental cubicle area,
 - 2 from the reactor pool to the fission product laboratory,
- Electrical power distribution capabilities: 1500 kW: 3 different quality of electrical power (normal, safety, reliable) are distributed.
- cooling capabilities: 2 MW,
- 2 ventilation circuits: one family extracting from experimental cubicle area and one family extracting from experimental cubicles having high radiological risk. .

View of the reactor building

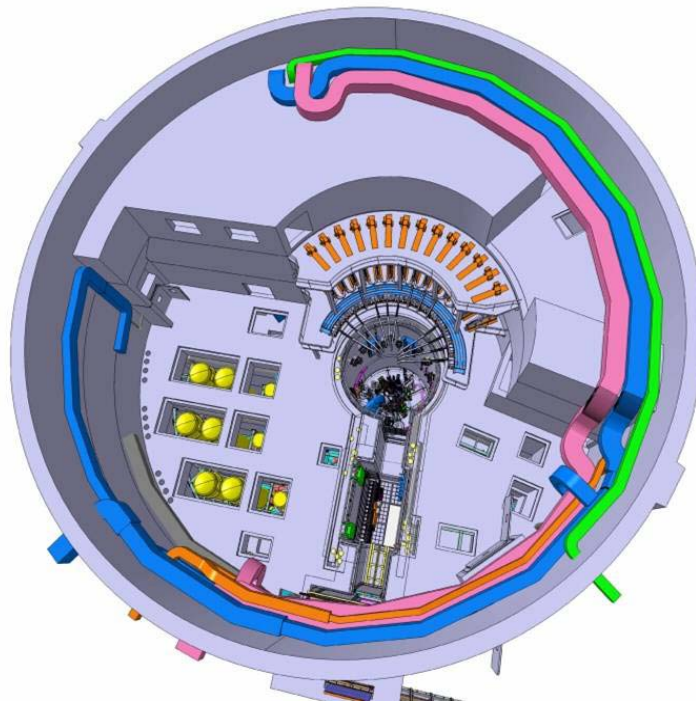

View of the experimental area

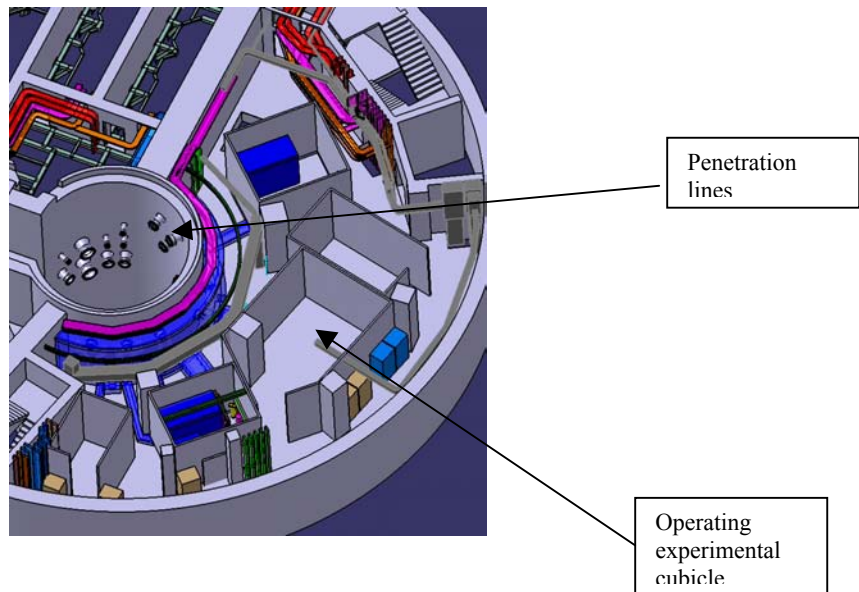

These areas are covered by the reactor hall handling crane ensuring a secured handling capability of 30 tons. There are also smaller handling cranes located at each floor. A dedicated equipment lift ensures the access to every floor.

Connection lines management principles:

Devices in pile can be connected to the experimental cubicle area through 9 penetrations (diameter 400 mm) passing fluids or electrical lines.

The non-irradiant pipelines and the electric lines can be directly routed from the reactor block to the experimental control cabinet area. Their length and the location of the lines are managed by a dedicated device above the reactor pool in order to allow for changes of the device position in the reactor pool without any disconnection.

2 penetrations in the reactor pool are dedicated for fission product measurement pipelines and are routed to the fission product facility. Development is on-going to design a multiple connecting plate ensuring all connections for an irradiation device and multiple wire umbilical.

The following pictures present the layout of the irradiation device in the reactor block.

Connections routing principles

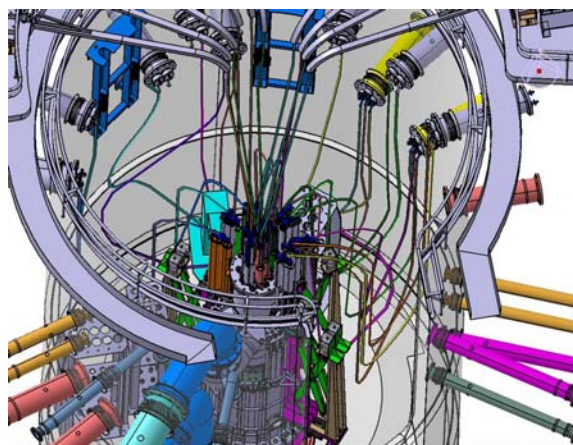

c) experimental devices typical design features

The internal diameters of the in core irradiation locations in the mid core plane are:

- 36 mm for the small locations inside a fuel element,
- 94 mm for the large location instead of a fuel element.
- 125 mm for the very large locations in the large configuration, in these locations, irradiation devices up to 110 mm external diameter may stay in the core during refueling operations.

The guaranteed internal standard dimensions of the experimental cells are as follows:

- internal diameter 25 mm for the small locations in the center of the element,
- internal diameter 50 mm for the large locations instead of a fuel element.

The reactor vessel lid and internal structures are designed in order to allow an increase in the diameter of the experimental device above the core: the standard external diameter of the experimental devices could be up to 120 mm and up to 140 mm for 2 locations which are located close to the core center.

The internal diameters of the in reflector irradiation locations in the mid core plane are:

- 100 mm for the standard locations,
- up to 200 mm for the biggest location.

The typical types of devices which could be irradiated in the JHR are:

- irradiation basket for radio-isotopes,
- capsules,
- compact forced convection loops with in-pile fluid driving,
- forced convection loops with out of fluid driving (cubicle area).

Depending on reactor configurations, hydraulic design parameters of cooling systems are given in the following table:

Nominal Power		
Configuration	Facility	ΔP (bar)
Reference	Core	6,7
	Reflector	< 0.6
Large	Core	4,8
	reflector	< 0.6

The cooling channel thickness used in this table is 2.5 mm for the devices situated inside a fuel element or in the reflector, and 3 mm for the largest devices in the core. Concerning devices gathering 3 small devices, a cooling channel of 3 mm is considered on the external diameter and three cooling channels of 2.5 mm for each small devices.

Studies assuming an exchange length of 2 meters showed that the flow rates dedicated to the devices can extract safely up to :

- 150 kW from each of the in core small capsules (inside fuel element),
- 500 kW from each of the large devices located in the core,
- 300 kW from each of the devices located in the reflector.

After reactor shut-down, cooling flow for the devices is maintained by:

- Forced convection for the devices located in the core and natural convection for the long term,
- Natural convection for the devices located in reflector.

Due to their dependence on the device design, hydraulic parameters for the reflector devices after shut-down (inversion of flow direction) have to be investigated case by case.

The irradiation devices in the reflector need to satisfy the following conditions:

- Power exchange length in the reflector: < 2m, diameter up to 200 mm,
- Interface data:
 - Inlet temperature: < 30°C,
 - Outlet temperature: < onset of nucleate boiling criteria at 1.4 bar,
 - Delta P: < 0.6 bar,
 - Cooling channel nominal width : 2.5 mm,
 - Device power up to 300 kW,
 - Irradiation device cooling channel section in each reflector block constant and limited to 500 mm².

d) irradiation performances

Performances are assessed with a dedicated experimental load composed with standard devices.

The geometry and composition of the standard devices are presented in appendix 1 .

d.1) fluxes and nuclear heatings :

The figures below present the fluxes and heating values calculated on the irradiation locations in the both JHR configurations. Calculations were performed with MCNP (version 4C2). The reactor is supposed to be functioning at a power of 100 MW with irradiated fuel. Control rods are in a critical position. The fuel management fraction are respectively 1/3 for the reference configuration and 1/5 for the large configuration. Fluxes and nuclear heating on irradiation devices are directly integrated on the samples of standard irradiation devices.

The standard devices are made of :

- stainless steel samples in Nak housed in stainless steel envelops for in core performance assessment,
- LWR fuel pin which is representative of a high burn-up fuel inventory in pressurised water in zircaloy and aluminium envelops for in reflector performance assessment.

Values are also averaged over a +/- 10 cm height around the midplane.

Core Performances Reference configuration

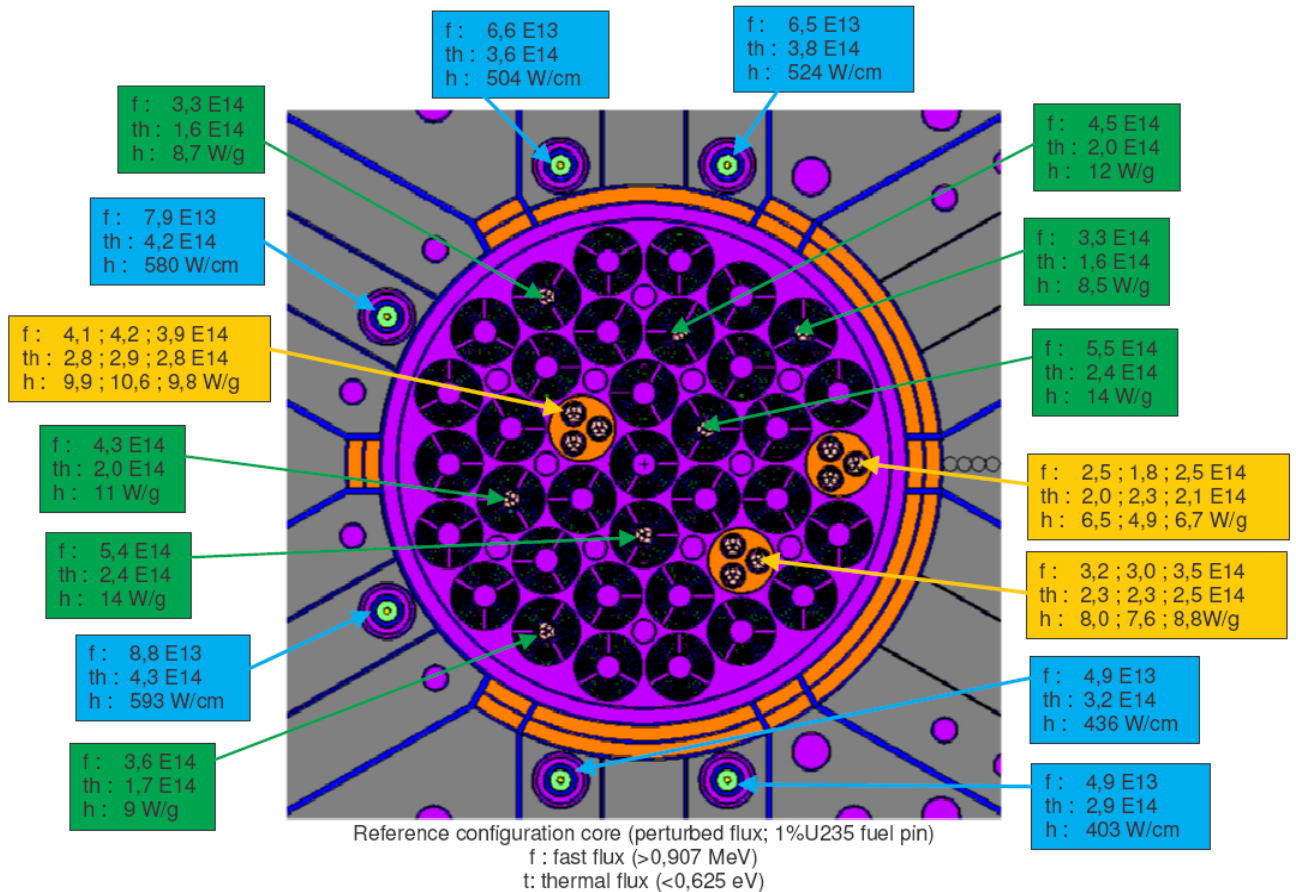

Large configuration

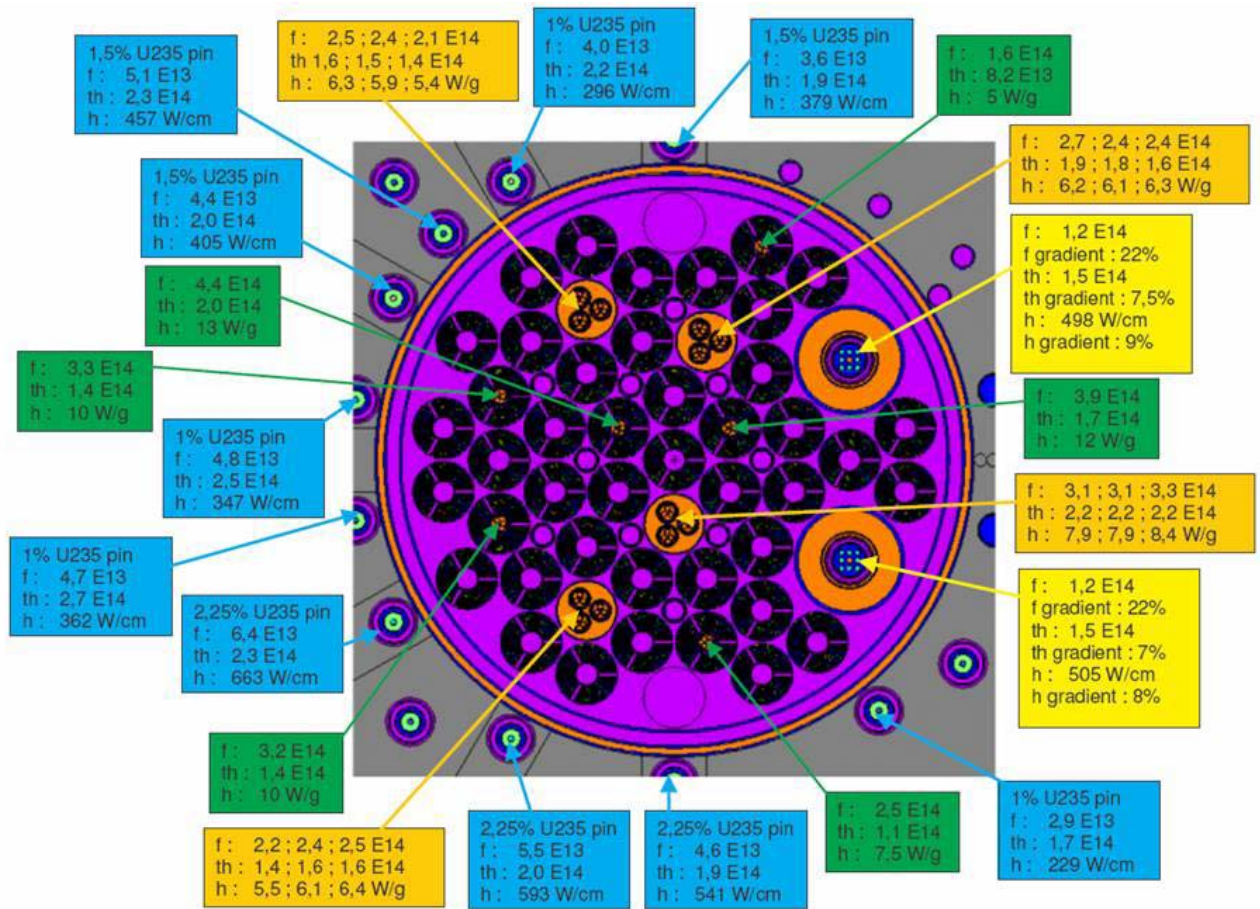

Legend :

Neutron fluxes ($n \cdot cm^{-2} \cdot s^{-1}$)

f: fast flux ($E > 0.907$ MeV) - th: thermal flux ($E < 0.625$ eV)

d.2) Displacement systems main characteristics

Up to 6 devices (8 in the large core configuration) are settled on displacement systems around the reactor tank:

– Maximum linear power :

- Up to 600 W/cm for a fuel rod enrichment of 1% (this corresponds to the nearest position without any gamma shielding),
- 660 W/cm for higher enrichments (>5%) with gamma shield.

- Standard power ramps (others performances are achievable if needed):

- The nominal power ramp is fixed at 200 W/cm/min,
- The maximum power ramp is about 600 W/cm/min.

The maximum speed of withdrawal is 50 mm/s.

The total travel of the displacement systems is about 350 mm.

The rear position is calculated so that the linear power is less than 10 W/cm (for a fuel rod with high enrichment > 5%).

Displacement systems characteristics

Fuel power = f (position) parametrical studies

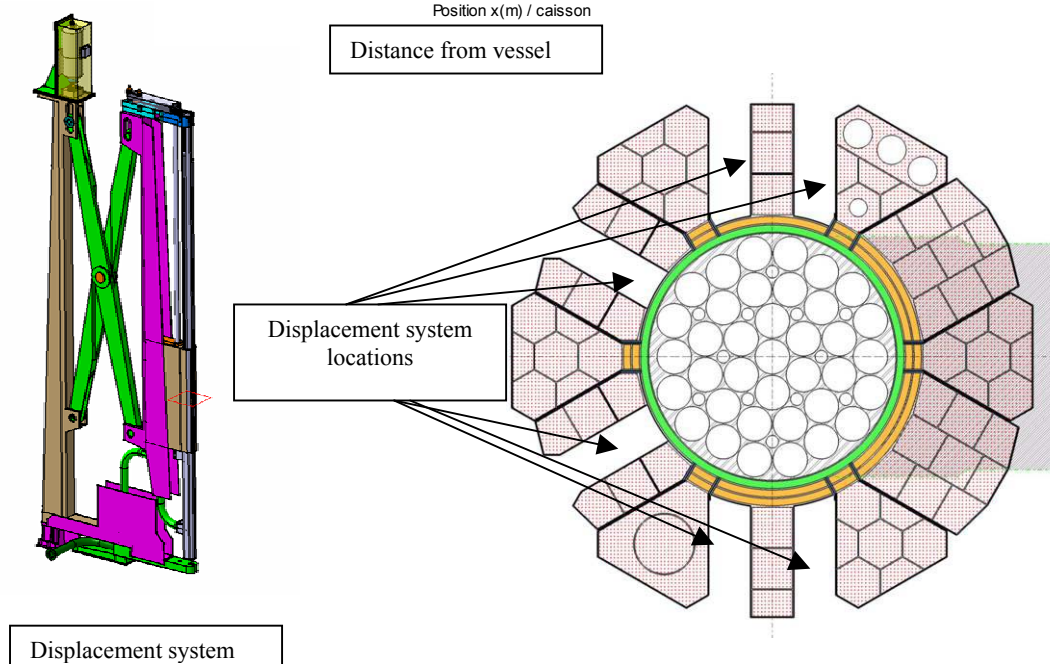
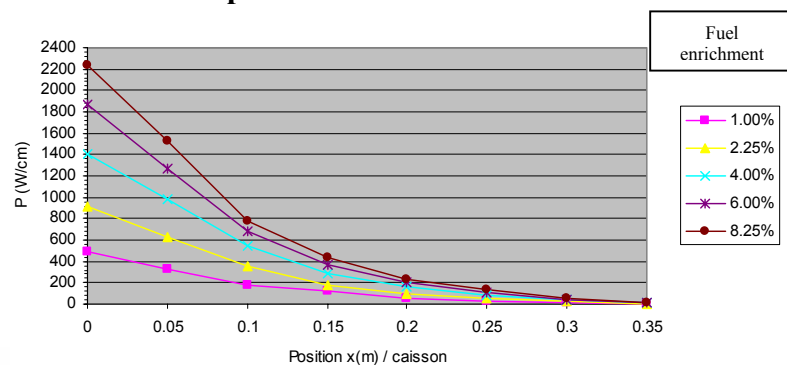

e) safety requirements:

Experiments are designed, constructed and operated within the safety referential of the facility which complies with up-to-date safety standards.

This unique set of safety standards and design and construction codes includes specific requirements for experimental devices dedicated to the in pile part of the design and the safety analysis (number of barriers, defence level, segregation rules, single failure criterion). The most important principles are summarized hereafter; Initially, the objectives and general criteria defined on the technical and material aspects as on the radiological level allow to specify, in a conventional way:

- The nominal number of barriers to be retained for the part "in core" of the device (i.e central part under neutron flux completed with external parts which can induce an interaction with the core) depending on the consequences of a complete hypothetical failure of this part of the experimental device (cf Table 1).
- The nominal number of systems of fixing or anti-take-off classified of safety to retain depending on the consequences resulting from the complete hypothetical shrinkage of the device.

Technical criterion		Radiological criterion
Material consequences		External radiological consequences *
No consequences: <ul style="list-style-type: none"> - On the core shut down - On the cooling capabilities of the fuel elements 	→	←
-	nominal number of barriers of the device in the core area	Annual authorization of rejections
<ul style="list-style-type: none"> - Impact limited on the core (fusion partial of fuel accepted) - No consequence on the reactor shut down - Evacuation of the power in the long term 	→	←
1	1	Equivalent with 10 mSv over one year
<ul style="list-style-type: none"> - serious Impact on the core 	→	←
2	2	No the immediate countermeasure**

Table 1: A nominal number of barriers to be considered for the design of the in core part of the device according to consequences of the hypothetical failure supplements this part

*The radiological consequences are calculated on the level of group of reference in terms of engaged dose, taking account the role of the reactor containment.

** Equivalent with 10 mSv over one week, by reference to the criterion of protection defined by the ministry for the health and the decree of 13 October 2003 relating to the levels of intervention in situation urgently radiological.

Nota : In any event, one must ensure that the integrity of the reactor containment is ensured, whatever the failure affecting device barriers.

Some examples of application in the facility design and experimental devices are outlined as follows:

- irradiation devices integrate 2 anti-lift-off device when located in the core and a minimal of one when located in the reflector,
- the primary circuit design integrates defense in depth features regarding a breakdown of an irradiation device in the core to avoid a core melting,
- the connection lines from the in pile part to the experimental cubicle are from a proven technology in operation at OSIRIS reactor,
- following the pressure increase and radiological consequences of a device failure in the experimental cubicle area, the containment, and ventilation are as follows:
 - when there is no pressure risk and the radiological consequences in the facility are limited to the upper limit IIa contamination area (following ISO standard rules), ie 80 Derived Air Concentration, no specific containment and ventilation are required, the experimental cubicle is connected to the normal ventilation network of the area .
 - when the consequences exceed these value, the experimental cubicle must ensure a containment function and the ventilation exhaust from the cubicle is connected to the high contamination ventilation network dedicated to IIIb contamination area.

f) operation control principles

The facility control room in the Nuclear Auxiliary Building groups together the control and monitoring equipment required for safe and reliable operation of the facility.

The experimental control room adjacent to the facility control room ensures

- monitoring the performance and safety of experiments, this task is done by the facility personal,
- controlling the irradiation devices and associated circuits during normal situations only, this task may be done by the experiment manager.

Experiment driving area

View of the control room

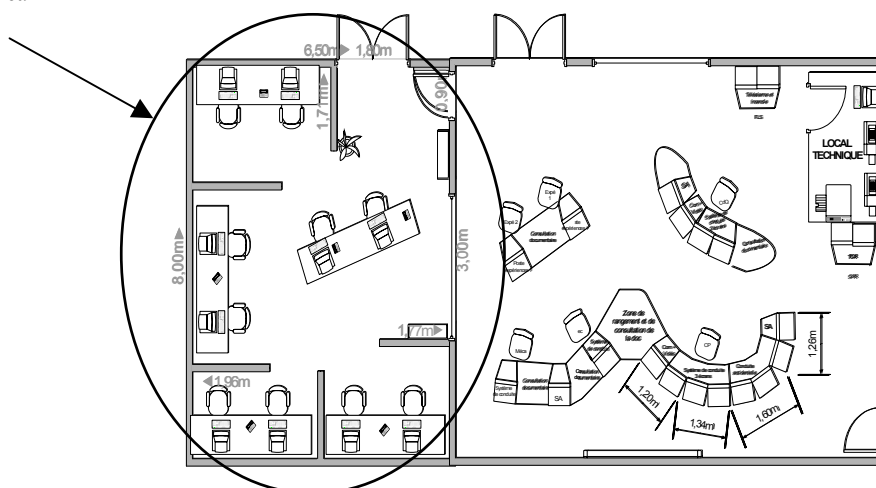

- Real time process of the irradiation data will be possible allowing on-line management of experiments parameters.
- Remote information will be available outside the facility.

g) devices instrumentation

Different developments studies will be foreseen in order to improve the quality of experiments:

- Increase of the access to the on-line experimental information:
 - o Sample temperature,
 - o Thermal hydraulic conditions,
 - o Chemical parameters,
 - o Applied constraints.
- Improvement of the access to new parameters & phenomena
 - o Degradation process of a fuel rod during power transient.
- Improvement of the control of the experiments
 - o Temperature homogeneity of the sample,
 - o Qualities of the fluids.

Specific actions of developments are planned or are identified in order to reach these objectives:

- Thermals , in-core , on-line

Sample	temperature range	Instrumentation	Clad	Production level
fuel and materials (SS,Zy,Al)	<1100°C	K type	SS/Zy	Industrial
	1000-1500°C	Mo-Nb / C	Nb, Re	Ind.+R&D
	>1500°C	UST* / JNPT**	Re	R&D
Irradiated clads	<1100°C	K type Welded or contact	SS/Zy	Industrial R&D

(*) UST : Ultra sonic thermometer.

(**) JNPT:Johnson Noise Power Thermometer

- On-line geometry

Sample	measurements	Instrumentation	Production level
Irradiated rods	diameter and length	LVDT Optic	Industrial R&D

- On line phenomena detection

Sample	detection	Instrumentation	Production level
Irradiated rods	Corrosion thickness		To be defined
	Cracks and breaking detection	US sensor microphone	R&D industrial
	Fuel movement	Fission chambers	R&D
	FP gas release	US sensors+ pressure sensors	R&D Industrial

h) fission products laboratory (on line and delayed measurements)

The JHR will be equipped of a Fission Product (FP) laboratory , adjacent to the reactor pool, able to deal with on line and off line experiment analysis of fission products released from the tested fuels. This laboratory will use the two dedicated penetrations through the reactor pool.

This laboratory will be made of different elements :

- One shielded cell dedicated for FP activities measurements in water :

The aim in this case is to follow on line the releases of fission products of non tight fuel rods of LWR reactors,

Another purpose will be the analysis of the coolant water after a constant power sequence or transient power scenario.

The equipment of this cell will be composed of

- An on line gamma spectrometer,
- A liquid sampling system for post-irradiation measurements,
- A delayed neutron detector,
- Others specific components (to be defined depending on experiments).

- One shielded cell dedicated for Fission Gases activities measurements (high level counting) :

The aim of this cell is to obtain measurements of:

- * on-line fission gas releases (depending of power level),
- * releases/ born ratio fission gases,
- * fuel/clad interaction knowledge,
- * activity release in case of accidental scenario,

Equipments of this cell will include:

- On-line gamma spectrometers,
- Gaseous cold traps,
- Gaseous chromatography allowing the measurement of compounds,
- Mass spectrometer,
- a system for gaseous sampling measurements.

- One glove box dedicated to low activities Fission gases measurements,

The aim of this cell is to measure on-line the fission gas releases for High Temperature Reactors (HTR) or GFR during constant irradiation sequences or specific transients.

Equipment of this cell will include:

- An on line gamma spectrometer,
- Different gaseous cold traps,

- One gloves box dedicated to post-experiment measurements after a radioactivity decay of the samples.

The aim of this cell is to measure after the experiment, activities of liquid and fission samples over a long period (few day to few months).

The FP lab will be connected with the in-pile experiments.

Connection lines can be heated and respect the thermal conditions of the experiments (i.e 320°C,150b for LWR irradiations).

Fission Products (FP) Laboratory

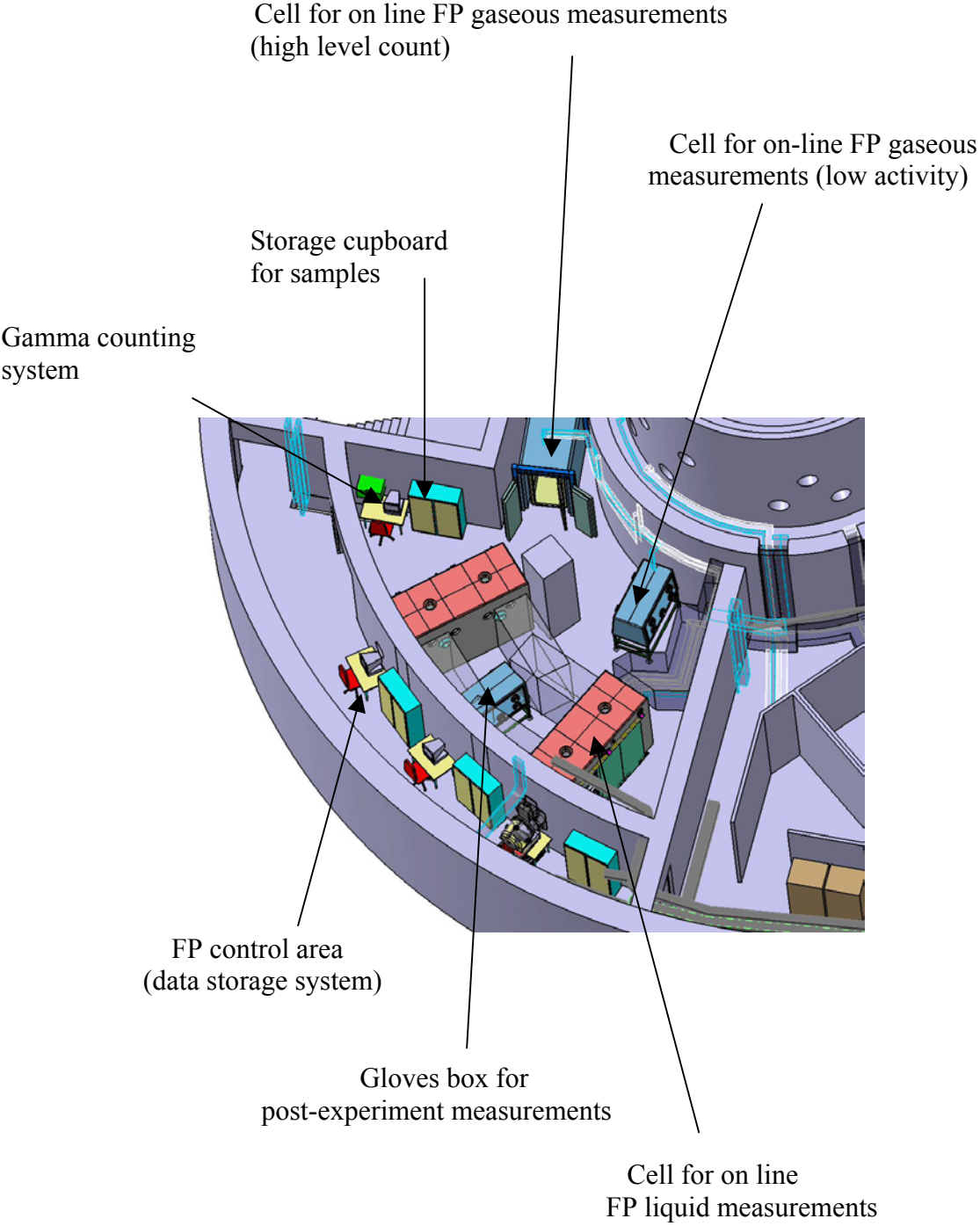

i) chemical measurements on samples

When it is required by the experiment, on-line chemical analysis devices is possible in cubicles (automats for sampling and analysis, on line measurements, etc.).

For the calibration purposes or for periodic samplings of devices fluids, chemical analysis are available in a hot laboratory settled in the nuclear auxiliary building.

This hot laboratory for low activity includes gloves boxes, extractor hoods and laboratory devices able to deal with samples of irradiated materials. Samples have to be handled without specific containment.

Several chemical analytical techniques are available :

- ionic chromatography
- photometry (colorimetry) for measurement of the anions, cations and metals,
- HPLC
- ICPMS (Inducted Coupled Plasma Mass Spectrometry)
- etc...

Chemistry Laboratory

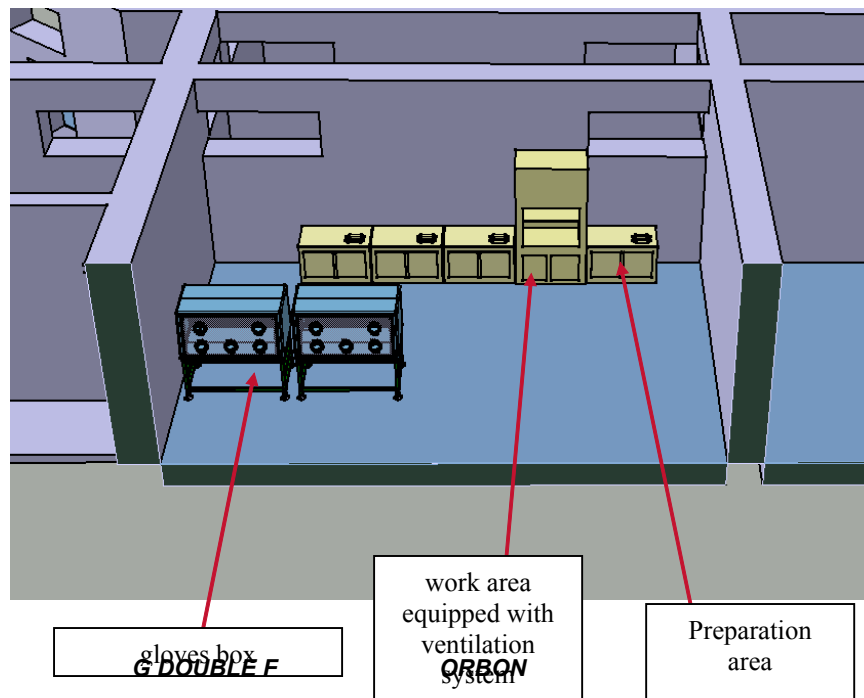

9. Non destructive examination on devices (radiography, gammagraphy, and neutronography) :

At different stages of the experiment, non destructive testing can be performed on devices in order to verify the aspect of the sample, and to obtain information on its characteristics after an irradiation cycle.

Non destructive testing systems will be placed in the reactor pool in order to obtain this type of information. They will be made of different elements:

Radiography, gammagraphy and neutronography are used for:

- Control of the overall aspect of the fuel rod or material samples after the transport or after irradiation sequences,
- Defect detection on the fissile rod,
- Comparison with measurements performed in hot cells,
- Gamma spectrometry of the sample loaded in the device,
- Burn-Up evaluation,
- Fission products inventory evaluation,
- Fission gas releases evaluation in the top of the device (LOCA experience),
- Irradiated radio-isotope quality control.

identification	measurement description	expected accuracy	location
X radiography	Density	100 microns	Pool of devices storage
X tomography by transmission	Material distribution		Pool of devices storage
Gamma spectrometer	FP and fuel activities	100 microns	Reactor pool
Tomography emission	Gamma emitters distribution		Reactor pool
Neutron radiography	Density		Reactor pool

Gamma spectrometer description:

This device located in the reactor pool, houses the irradiation device or irradiated samples loaded in a container.

The device is composed of different elements: gamma detector and components (stand, collimator, cryostat, I&C system). The irradiation device is filled with the fluid from the experience.

Investigation capabilities are as follows :

- A vertical displacement of the irradiated item: 800mm with a possible extension to 2,5m,
- An horizontal displacement of the irradiated item: +/- 100mm on each direction,
- Displacement velocity: 0.1 to 10mm/s
- Translation capabilities of the collimating system of 500mm and rotation from radial to tangential positions.
- Dimensions : Reactor pool 0.8x0.8x2m, experimental area : 8m²located at level -1

These measurements can be performed without disconnecting irradiation devices from their control system and from the umbilical.

**Gammagraphy system
in the reactor pool**

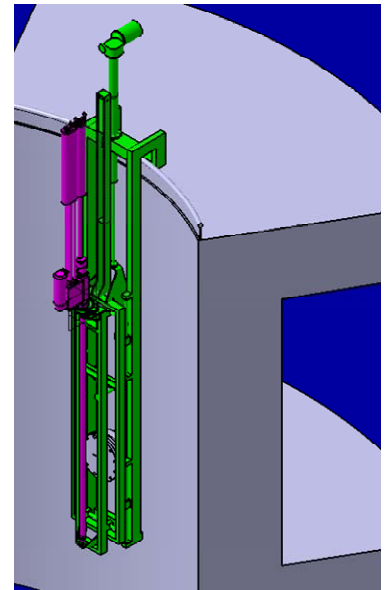
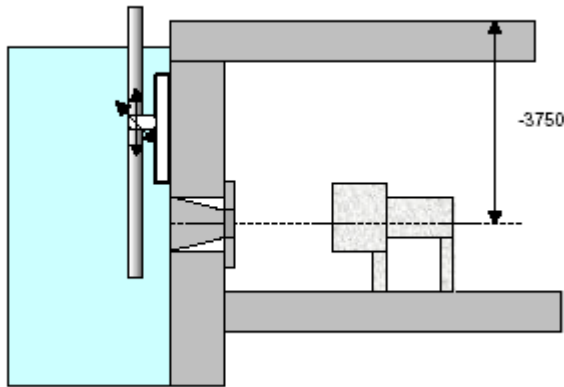

Neutron radiography:

In addition to the gamma spectrometer, non destructive investigations may be carried out by neutronography. In this case, the reactor works at low level.

For this examination, the device is empty (no fluid).

Performances required for the system:

- Thermal neutron flux $> 1e^{13} \text{ n.cm}^{-2}.\text{s}^{-1}$
- A vertical displacement of the irradiated item: 800mm
- Displacement velocity: 0.1 to 10mm/s
- A complete rotation of the device (in this case , non connection with the fluid utilities),
- A displacement pitch: 0.1mm.

The system will be equipped with a dynamic video system: high sensibility camera connected with remote control and monitoring units, data processing and associated software.

As for gamma spectrometer, these measurements may be performed without disconnecting the irradiation devices.

**illustration of the JHR Non Destructive Examinations systems
(location : JHR facility – reactor pool, level 0).**

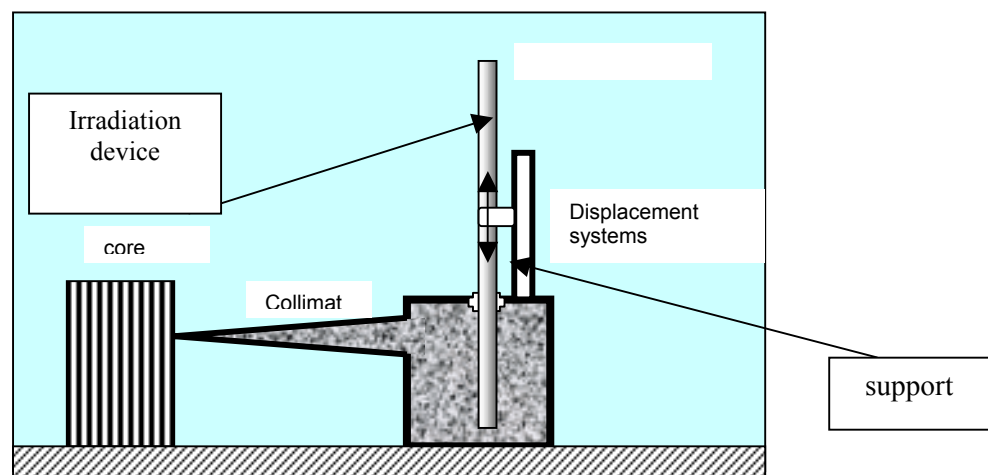

10. Recovery of the samples (cells, characteristic and state of the sources which can be accepted, kinematics, bases of dimensioning):

The NAB (Nuclear Auxiliaries Building) , directly connected to the Reactor Building through water channels for the transfer of devices, gathers a block hot cells which includes 3 cells at the service of the experiments.

This allows handling of the irradiating devices in open air and accessing samples during inter or post irradiation phases.

They are connected to the cells of Non Destructive Examinations (NDE), to the front zones to manage the remote operations and to the rear zones to connect transport casks.

Water transfer channel

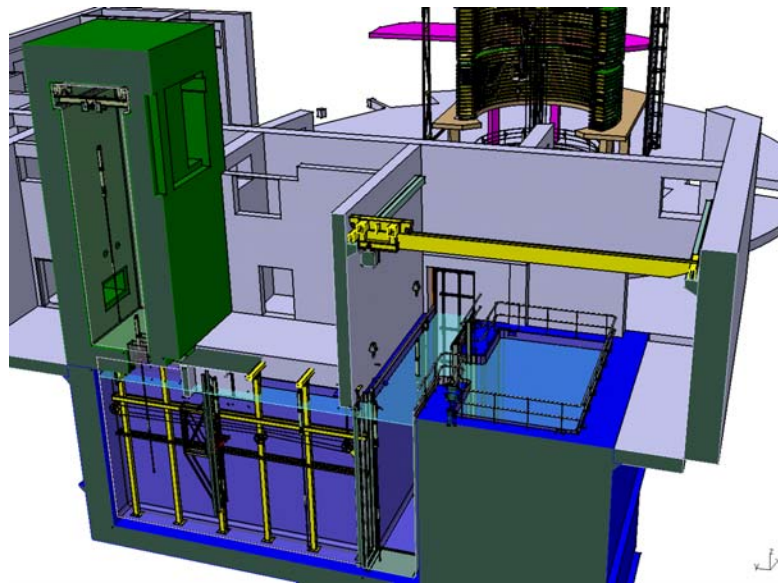

10.1) Hot Cell for experiments on materials

A cell is particularly intended for the experiments on **materials** or using molten metals as sample coolant. This cell can be inerted by nitrogen sweeping (oxygen content lower than 2 %) for sequences using pyrophoric materials or with risk of ignition .

This includes also:

- a heated well to allow the extraction of samples holders immersed in Na,
- a washing well for the sample holders including for the liquid metal washing (Na, NaK),
- washing means of the samples,
- wells for storage of the devices,
- tools allowing the final assembly of devices using manipulators.

This hot cell is also used for packaging operations of high activity wastes.

10.2) Hot cell for not damaged fuels experiments

A cell is more particularly dedicated to **fuel** experiments. This cell is equipped in a similar way to the material cell (except the equipments of management of the liquid metals) in order to provide some backup capabilities in the facility.

10.3) Hot cell for damaged fuels (alpha cell)

A cell is dedicated to the experiments on fuel whose risk of failure can reach fusion (RIA, LOCA,..). This cell is called **alpha cell** due to its alpha risk management capability. It will allow a tight and reversible connection with the alpha type devices, from a room under cell making use as well of a device conveyor, in a way comparable with a traditional connection of casks for cell rear zone.

Transfer of device between fuel and alpha cell

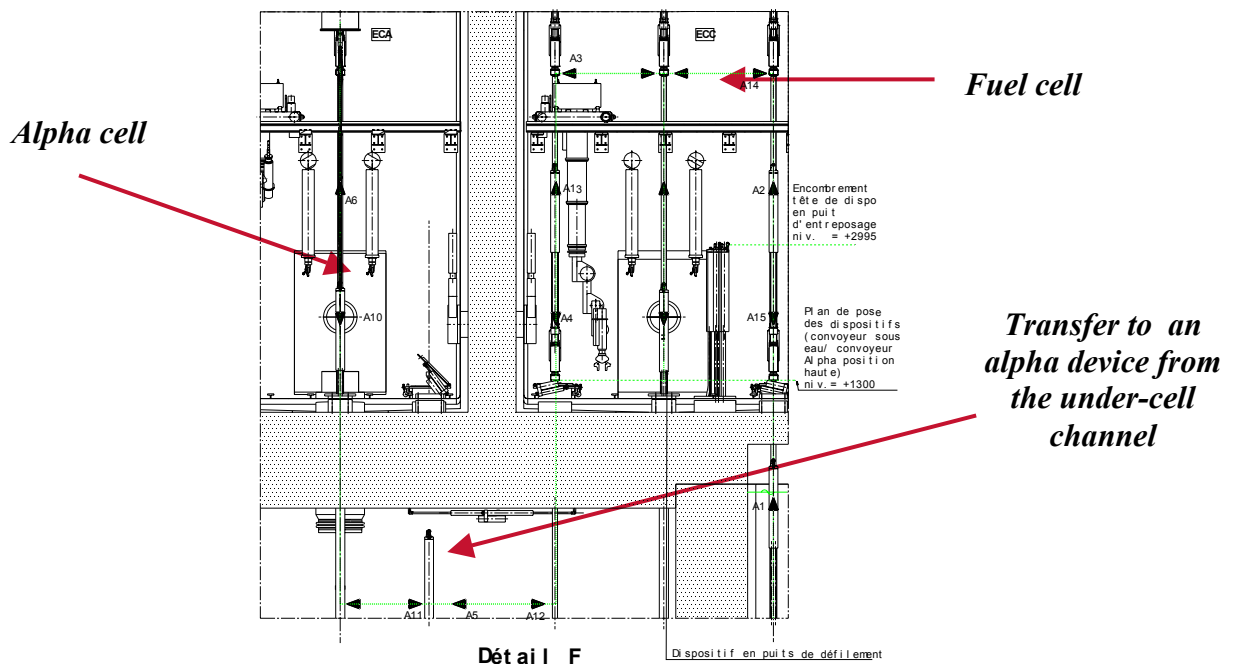

This reversibility will make it possible to carry out examinations between irradiation sequence during all phases of the damage progression of fuel samples, until significant clad failure occur. These examinations will be integrated directly into the cell alpha.

transfer equipment for transfer in alpha cell

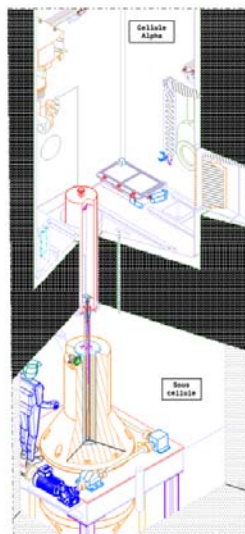

If the damage on the sample exceeds the clad cracking (partial or total fusions), the facility offer is limited to the recovery of the samples and their transfer to relevant laboratories for specialized examinations. The alpha device can be introduced into the cell which has all the equipment for dismantling and for conditioning. This can become necessary for accessing the sample and its conditioning before evacuation. The characteristics of the radiological source capable of being dealt with in the cells are summarized in the table below:

Sample type	characteristics	Mass, length	irradiation history	JHR irradiation
UO ₂	U ₅ <20%	315g, 600mm	BU < 120 GWj/t + 6 months cooling	2 to 400 JEPP
(U,Pu)O ₂	U ₅ =0.25% Pu / (U+Pu) < 40%	315g, 600mm	BU < 120 GWj/t + 6 months cooling	2 to 400 JEPP
recycled fuel	U ₅ < 12% Pu / (U+Pu) < 18.3% Am,Np,Cm	100g, 200mm	BU < 200 GWj/t + 6 months cooling	2 to 400 JEPP

11. Recovery of the dosimeters and measurement of integrated flows (laboratory of dosimetry):

Dosimeters can be recovered in hot cells with the same methods as for the samples. After identification they can be carried by pneumatic transfer to the laboratory of dosimetry part of the JHR allowing, within a short time, to precisely access the fluence integrated by the samples.

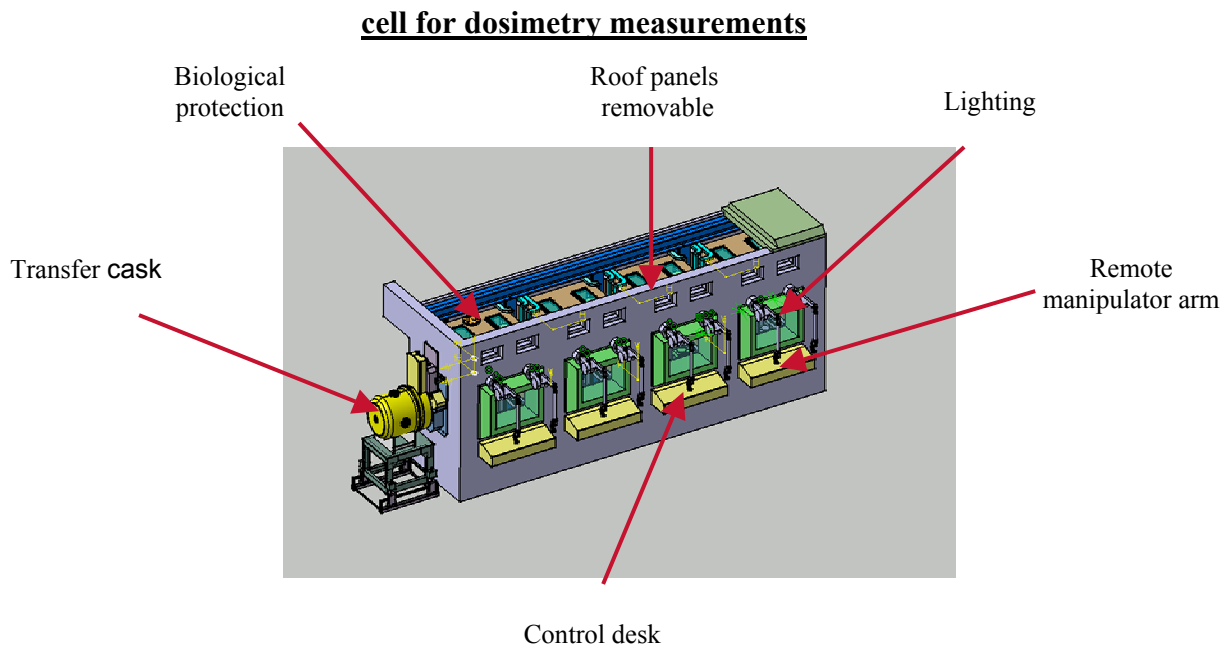

12. Non destructive examinations in the hot cells :

Before the start of the irradiation phase, the sample is assessed in order to determine its characteristics.

These operations are performed using specific and high technical devices.

At this stage of the design studies, the following measurements will be able to be performed on a irradiated sample before being loaded into the device:

Non destructive examination capabilities in the hot cells are outlined as follows:

description	equipment	expected accuracy
aspects	visual, microscopy, video	
dimensional (length, diameter, strain and profilometry)	traditional, laser	micron
weight and density measurements	balance	
corrosion layers and clad failures detection	eddy currents	

Characteristics of the NDE systems :

- materials 100x800x600mm
 - fuel: 2000x800x800mm
- Specific working constrains are defined for the NDE cells :
- Temperature range : 19 to 45°C,
 - Temperature variation : +/2°C by 24h,
 - Atmosphere : air,
 - Humidity : controlled,
 - Vibrations levels constraints.

After this examination , the sample is ready to be loaded in the irradiation device.

After the irradiation sequence, the sample is off-loaded of its device in hot cells, cleaned especially in case of experiment with NaK. It is then controlled on Non Destructive Examination devices for non contaminated fuel and material samples.

Non Destructive Examinations systems (location : JHR facility – hot cell level 1).

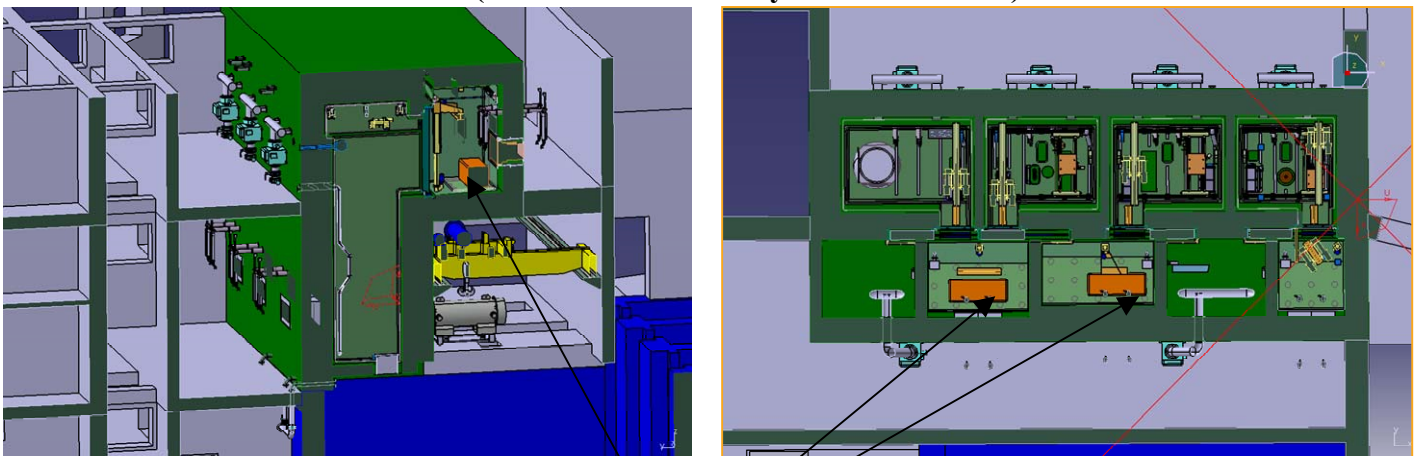

Non
destructives
examination
systems

hot cells equipments

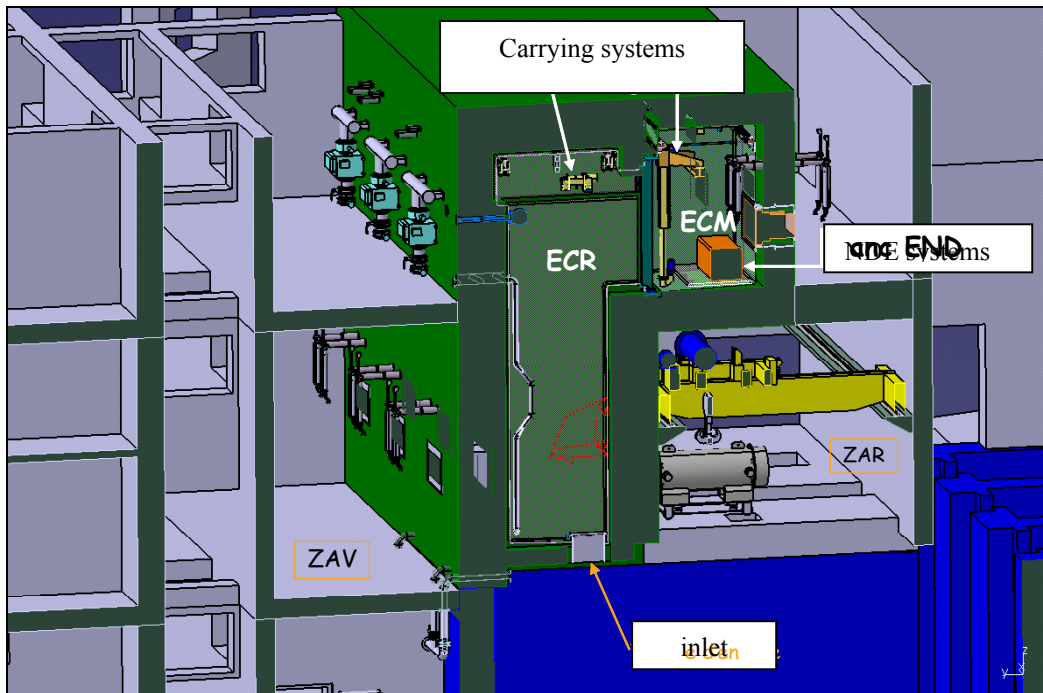

13. Recycling, multi recycling, re-use of the devices (equipment of storage reactor pool, recovery of components, glove boxes in the hot workshop):

In order to minimize the cost of the experiments and the production of wastes, JHR is designed to allow possible recycling of experimental devices owing to .

- a capacity of thorough dismantling allowing to sort and recover the components which can be recycled from devices (connectors, actuators, instrumentation, integrated pumps of the in pile device assembly, etc.),
- a capacity for remote manipulation allowing the assembly in cell of components on new devices,
- a glove box in the hot workshop allowing the re-use of parts and components weakly contaminated or irradiated to re-assemble devices,
- a suitable waste zoning .

14. Conditioning and evacuation of the samples :

In the same way that it has an important handling capability of samples (cf § 4), the JHR is designed with flexible interfaces for the evacuation of irradiated samples towards hot laboratories for fuel or material examination.

15.Dismantling (β , γ , α) :

JHR equipments allows a first level of dismantling and waste management consistently with the comprehensive CEA processes:

- capacity for underwater dismantling of irradiated solid waste $\beta\gamma$ (irradiated components pool),
- capacity for conditioning in hot cell (material cell $\beta\gamma$),
- capacity for dismantling and conditioning of devices and waste α (alpha cell),
- capacity for collection, storage and evacuation of liquids waste (α , β ou γ) connected to relevant CEA processes for liquid waste management
- capacity for collection, storage for decrease before discharge of particular gas effluents coming from the experiments or from the laboratory dedicated to the analysis of fission products,
- equipment for storage and characterization of very low activity solid waste, weak activity solid waste and high activity solid waste.

16.Experiment analyses :

The irradiation allows producing experimental results on a sample (fuel or material) depending on neutron flux, the thermal hydraulics of the experience and the applied constraints.

This irradiation data will be controlled following a protocol defined between customers and experimental team in charge of irradiations.

The information data will be monitored on line from instrumentation and controls systems specific to the experiments.

Data produced by the irradiation will be stored on digital media compatible with standard media and defined in the irradiation experience protocol.

17. Appendix

Standard devices characteristics

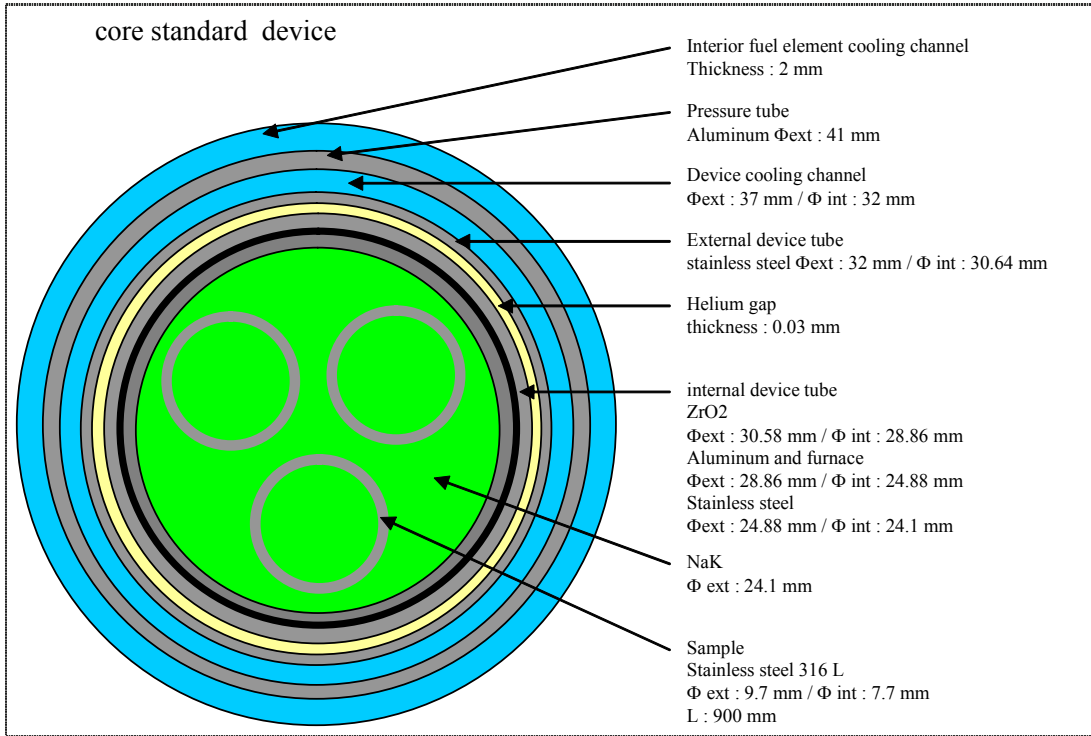

Reflector standard device

